

Measuring Pollutant Removal Efficiencies of Stormwater Treatment Units

Dr. Xiaoqi (Jackie) Zhang, PI
Assistant Professor
Department of Civil & Environmental Engineering
University of Massachusetts Lowell
Lowell, MA 01854

Prepared for
The New England Transportation Consortium
September 27, 2005

NETCR54

Project No. 03-4

This report, prepared in cooperation with the New England Transportation Consortium, does not constitute a standard, specification, or regulation. The contents of this report reflect the views of the authors who are responsible for the facts and the accuracy of the data presented herein. The contents do not necessarily reflect the views of the New England Transportation Consortium or the Federal Highway Administration.

Technical Report Documentation Page

1. Report No. NETCR54		2. Government Accession No. N/A		3. Recipient's Catalog No. N/A	
4. Title and Subtitle Measuring Pollutant Removal Efficiencies of Stormwater Treatment Units			5. Report Date 9/27/2005		
			6. Performing Organization Code N/A		
7. Author(s) Dr. Xiaoqi (Jackie) Zhang, PI Assistant Professor			8. Performing Organization Report No. NETCR__54__		
9. Performing Organization Name and Address Department of Civil and Environmental Engineering University of Massachusetts Lowell			10 Work Unit No. (TRAIS) N/A		
			11. Contract or Grant No. N/A		
			13. Type of Report and Period Covered Final Report		
12. Sponsoring Agency Name and Address New England Transportation Consortium 179 Middle Turnpike University of Connecticut, U-5202 Storrs, CT 06269-5202			14. Sponsoring Agency Code NETC 03-4 A study conducted in cooperation with the U.S. DOT		
			15 Supplementary Notes N/A		
16. Abstract This study evaluated the bacteria removal efficiency, and bacteria distribution and survivability within a structural BMP called Vortechs System (manufactured by Stormwater 360, formerly Vortechtechnics, Inc.) installed at two different sites in Providence, Rhode Island. Twelve rain events with precipitations greater than 0.1 inch were sampled over a two year period. Five pathogenic indicator bacteria, <i>E. coli</i> , <i>Enterococci</i> , Fecal <i>Streptococci</i> , Total Coliform, Fecal Coliform, were analyzed. Based on our research results, maintenance strategies such as more frequent sediment removal may be necessary to prevent pathogen-rich washouts to receiving waters. Structural BMPs near busy streets and highway should be cleaned out more frequently.					
17. Key Words Vortechs, pathogenic indicator bacteria, BMP		18. Distribution Statement No restrictions. This document is available to the public through the National Technical Information Service, Springfield, Virginia 22161.			
19. Security Classif. (of this report) Unclassified		20. Security Classif. (of this page) Unclassified	21. No. of Pages 29	22. Price N/A	

ABSTRACT

This study evaluated the bacteria removal efficiency, and bacteria distribution and survivability within a structural BMP called Vortechs System (manufactured by Stormwater 360, formerly Vortechics, Inc.) installed at two different sites in Providence, Rhode Island. Twelve rain events with precipitations greater than 0.1 inch were sampled over a two year period. Five pathogenic indicator bacteria, *E. coli*, *Enterococci*, Fecal *Streptococci*, Total Coliform, Fecal Coliform, were analyzed.

Results showed that Vortechs was effective in partial removal of pathogenic indicator bacteria (39-86%), however, the bacteria concentrations after Vortechs treatment were still significantly high and this could limit the use of receiving waters and raise concerns for public health. In the sump water, a surge of bacteria concentrations happened on the day a rain event occurred and one-day after the rain stopped. Higher bacterial concentrations were detected in the sediments than that in the sump water. The survivability of bacteria was low in the sump water but high in the sediments, suggesting that sediments may provide a favorable living environment for bacteria and the surge of bacteria in the sump water may be due to bacteria re-suspension from the sediments. Majority of the bacteria were associated with smaller particles (<50 μm in the sump water, and <106 μm in the sediments). Apparently *Enterococci* and Fecal *Streptococci* can survive longer than *E. coli* under colder temperature. The sump water at Site 2 had much lower bacteria concentrations than that at Site 1 suggesting a higher bacteria contamination from highway runoff. The ratios between Fecal Coliform to Fecal *Streptococci* suggest that the contamination source is human.

Based on our research results, maintenance strategies such as more frequent sediment removal may be necessary to prevent pathogen-rich washouts to receiving waters. Structural BMPs near busy streets and highway should be cleaned out more frequently.

Table of Contents

1. Introduction	1
1.1 Background	1
1.2 Purpose/Objectives	3
1.3 Scope of Research	3
1.4 Organization	3
2. Methods	3
2.1 Sampling Sites	3
2.2 Rain Events Monitoring	7
2.3 Sampling	7
2.4 Pathogenic Indicator Bacteria Analysis	7
2.5 Sump Water Analysis	8
2.5.1 Particle Separation in the Sump Water	8
2.5.2 Bacteria Distribution in the Sump Water	8
2.5.3 Particle Size Distribution in the Sump Water	8
2.6 Sediments	8
2.6.1 Particle Separation in the Sediments	8
2.6.2 Bacteria Distribution in the Sediments	9
2.6.3 Particle Size Distribution in the Sediments	9
3. Results and Discussion	9
3.1 Rainfall Record	9
3.2 Background Information	10
3.3 Removal Efficiency of Pathogenic Indicator Bacteria	11
3.4 Temperature, pH, and DO	11
3.5 Particle Size Distribution	13
3.6 Bacteria Distribution within Vortechs	15
3.7 Bacteria Survivability	16
3.8 Ratio of Fecal Coliform to Fecal <i>Streptococci</i>	22
4. Conclusions	22
5. Recommendations for structural BMP management	23
6. References	23

List of Tables

Table 2-1. Sampling Sites	4
Table 3-1. Rainfall Information	10
Table 3-2. Background Bacteria Concentrations during Dry Weather	10
Table 3-3. Bacteria Removal Efficiency	11
Table 3-4. Impact of Vortechs on Bacteria Removal at Site 2	11

List of Figures

Figure 2-1. Vortechs TM Stormwater Treatment System (Vortechtechnics, Inc.)	4
Figure 2-2. Location and Schematics of Sampling Site 1	5
Figure 2-3. Location and Schematics of Sampling Site 2	6
Figure 3-1. Temperature, pH, and DO in the Sump Water	12
Figure 3-2a. Particle Size Distribution in the Sump Water (Site 1)	13
Figure 3-2b. Particle Size Distribution in the Sump Water (Site 2)	14
Figure 3-3. Particle Size Distribution in the Sediments	14
Figure 3-4. Bacteria Distribution in the Sump Water	15
Figure 3-5. Bacteria Distribution in the Sediments	16
Figure 3-6a. Bacteria Survivability in the Sump Water (Site 1)	17
Figure 3-6b. Bacteria Survivability in the Sump Water (Site 2)	18
Figure 3-7a. Bacteria Survivability in the Sediments (Site 1)	20
Figure 3-7b. Bacteria Survivability in the Sediments (Site 2)	21
Figure 3-8. Ratio of Fecal Coliform to Fecal <i>Streptococci</i>	22

1. Introduction

According to U.S. Environmental Protection Agency (USEPA)'s 1998 National Water Quality Inventory Report to Congress, about 40% of assessed US streams, lakes, and estuaries did not meet the criteria for locally designated uses such as fishing and swimming. High bacterial concentrations in stormwater runoff from agricultural and urban areas are a leading cause in the failures to meet designated use criteria [1]. Large concentrations of fecal coliform and pathogens such as *Pseudomonas aeruginosa* and *Staphylococcus aureus* in urban stormwater have been found [2]. Besides pathogenic organism, high concentrations of total suspended solids, organic pollutants, heavy metals are commonly found in stormwater; major sources of these pollutants include highly traveled highways, gas stations, factories, and wash-off of street dirt, fertilizers and pesticides, etc.

Stormwater pollution is receiving priority attention from the USEPA in watershed management. Many new regulations have been enacted for the stormwater quality control in the past ten years. 1987 Water Quality Act directs the USEPA to regulate stormwater runoff quality. A common requirement of all of these stormwater regulations is the use of best management practices (BMPs) to remove pollutants from stormwater runoff and improve water quality. Some of the more conventional BMPs utilized are detention ponds, infiltration basins, grassed swales and buffers. In urban areas where land availability is low and cost is high, space-consuming BMPs such as these are not always feasible. Hydrodynamic separator units are ideal for areas where land availability is limited.

Hydrodynamic separator units have been installed in many locations throughout the United States and abroad as structural BMPs. These units are designed to treat stormwater runoff by capturing floatable debris, oil & grease and reducing Total Suspended Solids (TSS) concentrations [3]. Most pollutants transported by stormwater are associated with suspended particles [4, 5] and sediments [6], for example, about 80-85% of fecal coliform cells present in untreated stormwater were reported to be adsorbed to less than 30 μm suspended particles [7], metals were found to be predominantly associated with mid-range and coarse particle sizes with a diameter of 50 μm or more [8]. However, no sufficient evidence has been provided to evaluate whether structural BMPs are effective in reducing bacteria loading to receiving waters and bacterial survivability within structural BMPs.

1.1 Background

Microorganisms are ubiquitous in all aquatic ecosystems. Of the vast number of species, only a small subset is human pathogens, capable of causing varying degrees of illness in humans. The source of these harmful organisms is usually the feces or other wastes of humans and various other warm-blooded animals. The pathogens most commonly identified and associated with waterborne diseases can be grouped into three general categories: bacteria, viruses, and protozoa [9].

The detection and enumeration of all pathogens of concern is impractical in most circumstances due to the potential for many different pathogens to reside in a single water body, lack of readily available and affordable methods, and the variation in pathogen concentrations. The use of

indicators provides a means to ascertain the likelihood that human pathogens may be present in recreational waters [9].

Indicator microorganisms: are used to predict the presence of and/or minimize the potential risk associated with pathogenic microbes. Indicator organisms are useful in that they circumvent the need to assay for every pathogen that may be present in water. Ideally, indicators are non-pathogenic, rapidly detected, easily enumerated, have survival characteristics that are similar to those of the pathogens of concern, and can be strongly associated with the presence of pathogenic microorganisms [10].

Reliance on a single indicator may not be desirable as a general rule. In general the following bacterial indicators are considered: *E.coli*, *Enterococci*, *Fecal streptococci*, Total Coliform, and Fecal Coliform. These indicators are used individually or in combinations depending upon the specific objective of the study.

Fecal Coliform is an indicator organism that represents total pathogenic organisms present in various water. However, survival time for coliform bacteria is substantially less than that for many pathogens [11]. This complicates the efforts to correlate counts of fecal coliform bacteria with the densities of pathogens at any specific time. For these reasons data on fecal coliform bacteria cannot in themselves be considered adequate for a thorough assessment of public health risks. Fecal coliform bacteria continue to be used as an indicator because other indicators also have deficiencies, and because measurements of fecal coliform bacteria provide a basis for comparison with historical data.

In 1986, EPA issued a revision to its bacteriological ambient water quality criteria recommendations to include new indicator bacteria, *E. coli* and *Enterococci*, which provide better correlation with swimming-associated gastrointestinal illness than the previous criteria recommendations for fecal coliform bacteria.

E. coli: The lack of specificity of fecal coliform bacteria to fecal coliform pollution prompted the development of a membrane filtration method for enumerating *E.coli* [12]. Unlike fecal coliform bacteria as a group, *E.coli* is specific to mammalian fecal pollution. It has good characteristics of fecal indicator, is normally non-pathogenic and is present at concentrations much higher than the pathogens it predicts [13].

Enterococci: are a subgroup of Fecal *Streptococci* indigenous to the intestines of warm blooded animals. US EPA (1986) recommends their use as indicators of fecal pollution in recreational waters because enterococci may die off more slowly in sediments than fecal coliform bacteria [14], and therefore be better indicators of sediment contamination.

Fecal *streptococci*: can be used to indicate the contamination source from animals. Fecal Coliform to Fecal *Streptococci* ratio is used to determine whether the source of fecal pollution is human or animal. The Ratio of > 4.0 indicates human pollution and a ratio of <0.7 indicates nonhuman pollution [13]. The rationale behind the use of this method was the observation that human feces contain higher levels of Fecal Coliform, while animal feces contain higher levels of

Fecal *Streptococci*. However this approach is considered unreliable due to variable survival rates of Fecal *Streptococci* species and variations in detection methods [15].

Bacteria associated with particles: A significant portion of microbial activity occurs in microbial communities associated with particles. Association of bacteria with particles alters the sedimentation and transport rates of microbes; hence identification of bacteria associated with particles could improve predictions of the fate of microbes [16].

1.2 Purpose/Objectives

The objectives of this study were to

- (1) develop a “bacteria budget” to track influent and effluent bacteria concentrations as well as measuring the growth or reduction of bacteria within the structural BMPs;
- (2) determine the potential of bacteria re-suspension;
- (3) determine the extent of bacteria survivability in hydrodynamic separator units;
- (4) determine bacterial distribution in the structural BMPs.

This study will provide information on the fate of bacteria in a structural BMP and provide better understanding of the impact of structural BMPs in stormwater management.

1.3 Scope of Research

This project started with sampling site selection to ensure representative samplings. Three major tasks were performed to evaluate the performance of hydrodynamic separators by determining the removal efficiency of five pathogenic indicator bacteria, the extent of bacteria re-suspension and survivability, and bacteria distribution in Vortechs.

1.4 Organization

This report is organized by sections. Section 1 introduces the research background and objectives. Section 2 describes methods used for the entire study. Section 3 discusses the results. Section 4 provides conclusions for this study. Section 5 provides some recommendations for stormwater management based on our findings. Section 6 lists all the references used in this report.

2. Methods

2.1 Sampling Sites

Two existing Vortechs Stormwater Treatment Units (Figure 2.1, Vortechtechnics, Inc.) installed at two different sites in Providence, RI were selected for this study. They are selected based on their close proximity to one another (approximately a five-mile radius) in order to maintain comparable rainfall and antecedent conditions.

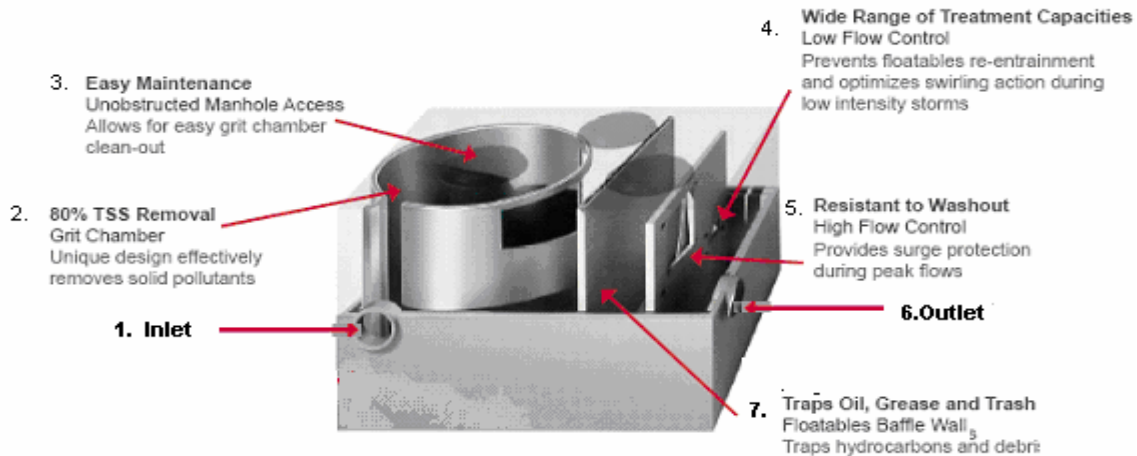

Figure 2-1. Vortechs™ Stormwater Treatment System (Stormwater 360, formerly Vortechics, Inc.)

Vortechs' design combines two treatment structures to eliminate turbulence within the system - ensuring proper physical separation and capture of sediments and oil. It has three major components: Grit Chamber, Oil Chamber and Flow Control Chamber.

An inlet tangential to the circular grit chamber channels storm water into a vortex-like flow path. This swirling action directs sediment into the center of the chamber, where it accumulates in a stable pile. Oily contaminants floating in the grit chamber are then trapped by a sealed oil barrier. As the storm event builds in intensity, the flow controls cause the inlet to become submerged, preventing influent from disturbing previously captured contaminants above and below the influent stream. These combinations of swirl-concentrator and flow-control technologies work to abate forces which encourage re-suspension and washout [17].

The model and configurations of each unit are shown in Table 2-1. The map location and flow schematics are shown in Figures 2-2 and 2-3. Prior to the start of the study, these units were thoroughly cleaned on May 20th, 2004 to ensure they were free of sediment, standing water and debris.

Table 2-1. Sampling Sites

	Site 1 (Figure 2-2)	Site 2 (Figure 2-3)
Location	Charles Street next to Route 146 North Ramp	Garfield Ave. In a parking lot in front of a restaurant
Model	7,000	11,000
Peak flow rate	11 cfs	17.5 cfs
Dimensions	14ft × 8ft	16ft × 10ft
Effluent is discharged to	A central piping system	Spectacle pond

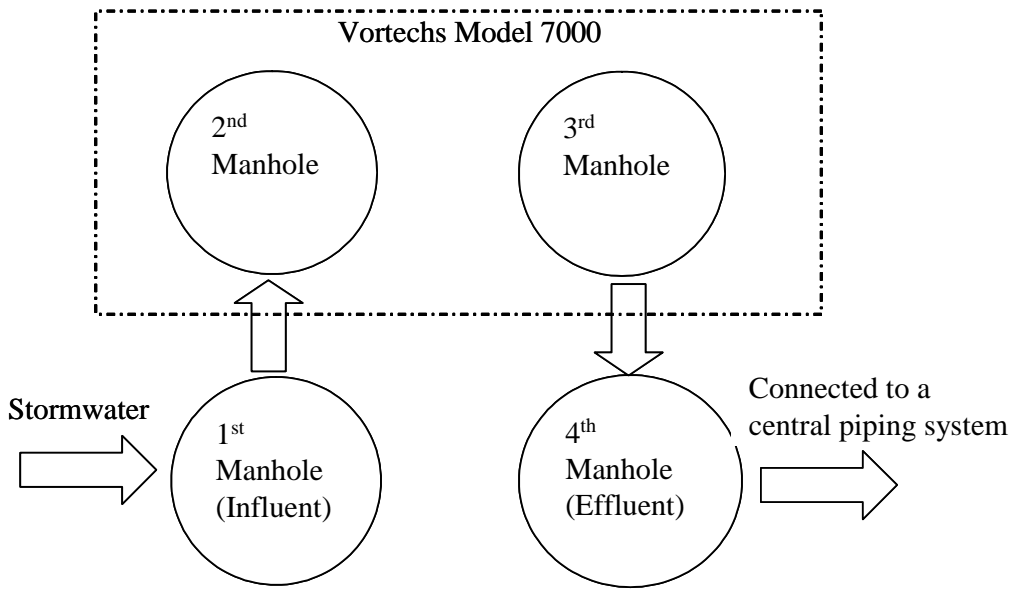
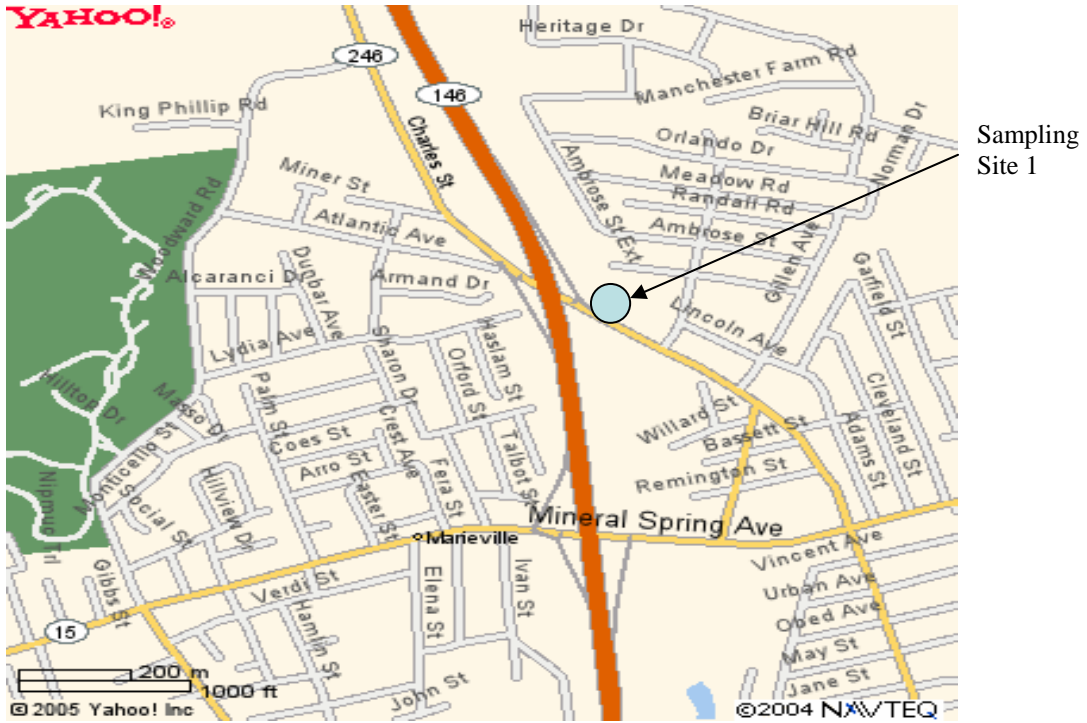

Figure 2-2. Location and Schematics of Sampling Site 1

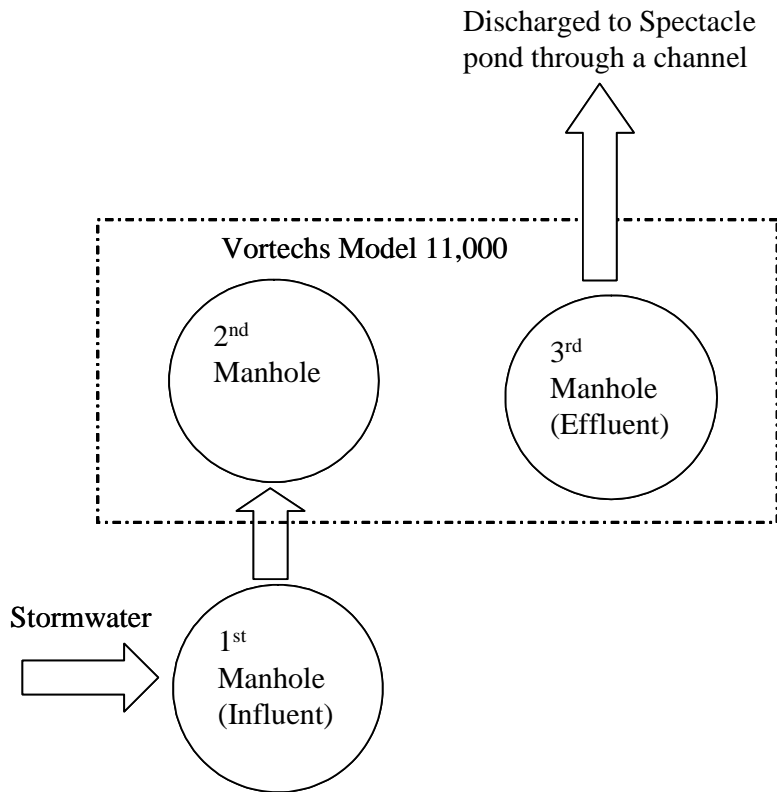
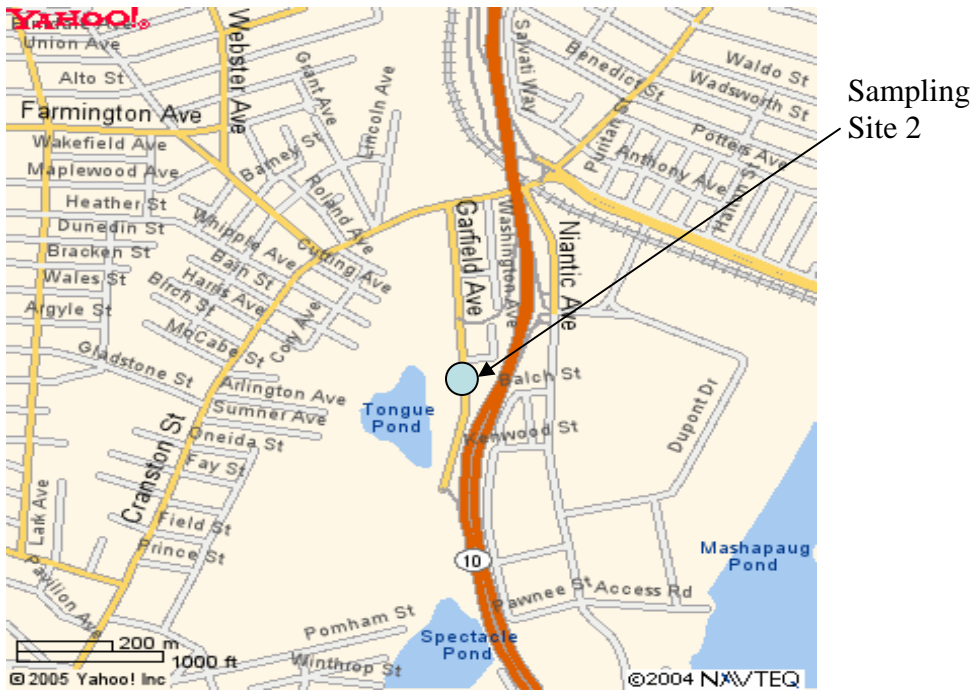

Figure 2-3. Location and Schematics of Sampling Site 2.

2.2 Rain Events Monitoring

Each rain event was monitored by a rain gauge (American Sigma Model 2459) located on the rooftop of the Department of Transportation in Providence, Rhode Island. The rain gauge records the precipitation amounts in inches and duration of each storm. It is connected to a computer to allow the rainfall data to be downloaded.

2.3 Sampling

Studies were performed on twelve storm events that had rainfall depths of at least 0.1 inch or greater. A grab sample of influent, effluent, and stream was taken during three rain events (R1, R11, and R12, see Table 3-1) to perform bacterial removal efficiency analysis. A grab sample of sump water and stream was taken from the 2nd manhole above the Vortechs treatment units (see Figures 2-2 and 2-3) during dry weather conditions to get background information; a grab sample of sump water and sediments was taken from the 2nd manhole at 1 day, 3 days, and 5 days (7 or 8 days for R10, and R8, respectively) after the cessation of ten rainfalls to perform bacterial survivability and distribution analyses. The sump water was taken within 1 ft of the water surface using a swing sampler (RABCO, Inc.) and the sediments were taken by a hand auger (Forestry, Inc.). Temperature, pH, and dissolved oxygen (DO) concentration of the sump water samples were measured on site using a portable meter (Multi 340i, WTW).

USEPA microbiology methods manual [18] was followed as a standard sampling procedure. Samples were collected in HDPE bottles, properly labeled, tagged, and stored in insulated ice containers at a temperature of 1-4°C and transited to the environmental laboratory at UMass Lowell for immediate analyses. All bacterial analyses were initiated immediately after the samples arrived the lab, and finished within 8 hr after collection of the samples as required by the EPA [19].

2.4 Pathogenic Indicator Bacteria Analyses

Five pathogenic indicator bacteria were used in this study; they were *E. coli*, *Enterococci*, Fecal *Streptococci*, Total Coliform, and Fecal Coliform. Bacteria analyses were performed on all samples collected (influent, effluent, stream, sump water, and sediments). Duplicates were run for each analysis. Phosphate buffered dilution water was used for serial dilutions. Throughout the study, all glassware, media, particle separation units, filtration units, and phosphate buffered dilution water were either sterilized by autoclaving or UV sterilization.

E. coli is a member of fecal coliform group of bacteria. The presence of this organism in water indicates fecal contamination. It can be measured using modified m-TEC agar (EPA Membrane filtration method 1603 [20]).

Enterococci are a subgroup of fecal streptococci indigenous to the intestines of warm blooded animals. Membrane filter test method using mEI agar (EPA Method 1600, 1997) was used to measure the amount of *enterococci* in the samples.

Fecal *Streptococci* are used to indicate the contamination source from animals. It was measured using m-Enterococcus agar (Membrane Filtration Method 9230A [15]).

Total Coliform The coliform group consists of several genera of bacteria belonging to the family Enterobacteriaceae. When fermentation technique is used, this group is defined as all facultative anaerobic, gram-negative, non-spore-forming, rod-shaped bacteria that ferment lactose with gas and acid formation within 48 h at 35°C (MPN Method 9221B) [15]. This method is used as a screening tool for the presence of fecal contamination.

Fecal Coliform is used to distinguish those total coliform organisms that are fecal coliforms. Fecal coliform count will be conducted by following MPN Method 9221E [15].

2.5 Sump Water Analysis

2.5.1 Particle Separation in the Sump Water

A liquid particle separation method was developed. A filtration unit was set up with two 1.5” PVC connectors purchased from The Home Depot and a 100 µm nylon mesh (Sefar America Inc.) was inserted into the connectors to collect the sump water with particles less than 100 µm. Another identical filtration unit with a 50 µm nylon mesh was set up to collect the sump water with particles less than 50 µm. Each unit is autoclavable and samples were filtered by gravity.

2.5.2 Bacteria Distribution in the Sump Water

The original sample and the two samples (<50 µm and <100 µm) obtained from the filtration procedure were used for all bacterial analyses. The bacteria associated with particles 50-100 µm and >100 µm were then calculated from the experimental data. Serial dilutions were made on the samples. For the membrane filtration methods, 10 ml of a diluted sample was passed through a membrane filter using magnetic filter funnel assembly (Gelman Sciences). Fixed dilutions were selected through trial and error during the first rain event and dilution rates vary depending on the type of sample (i.e. influent, effluent, stream, sump or sediments), sampling site, and the type of bacteria being determined. For the MPN method, 1 ml of diluted sample was added into each culture tube filled with 9 ml media with an inverted Durham’s tube inside. Depending on the number of positive tubes observed (gas production), the Most Probable Number (MPN)/100ml of sample was calculated using the MPN index.

2.5.3 Particle Size Distribution in the Sump Water

Particle size of the sump water samples were analyzed by a PC-2200 Laser Particle Counter (Spectrex) (0-100 µm). Dilution is often needed to have particle numbers within the detection limit. Necessary dilutions were made by adding distilled water ASTM Type II (Fisher Scientific) to the samples. A diluted sample volume of 100 mL was used for all analyses.

2.6 Sediments Analysis

2.6.1 Particle Separation in the Sediments

A wet sieving method was optimized to best represent the pathogenic indicator bacterial concentrations in the sediments. A setup consisted of two sieves with aperture sizes of 425 µm (40 mesh) followed by 106 µm (140 mesh) and a collecting pan (Retsch GmbH & Co. KG) were

mounted on a sieve shaker (Cenco-Meinzer 18480). A wet sediment sample of 100 g was loaded to the upper sieve (425 μm) and the sieve shaker was run for 5 minutes with the speed dial set at '8' (optimized running conditions, results not shown). This procedure allows the separation of particles with different sizes. During the sieving, 500 mL of phosphate buffered dilution water was applied to the sample continuously to allow the smaller particles to move downward. The particles retained on 425 μm had the size of greater than 425 μm ; the particles retained on 106 μm had the size of 106 – 425 μm ; the particles in the collecting pan had the size of less than 106 μm .

2.6.2 Bacteria Distribution in the Sediments

After sieving, the sediments retained on 425 μm and 106 μm sieves were each transferred into a 1000 mL beaker. The particles trapped on the sieves were removed by back washing with a squirt bottle. The contents in the beaker were then transferred to a sterile conical flask, and the volume was brought up to 1000 mL with phosphate buffered dilution water (this is 10^{-3} dilution). Each flask was shaken vigorously 50-60 times, after which the sediments were allowed to settle for 10 minutes [21]. Similarly, sample in the collecting pan was transferred to a flask and the volume was brought up to 1000 mL with dilution water. The supernatant of 10 mL was taken for serial dilutions and pathogenic indicator bacteria analysis was performed. Original sediment sample was also used for bacterial analysis to cross-check the results. An original wet sediment sample of 100 g was transferred to a 1000 mL conical flask. The same procedure as described above was followed to de-sorb bacteria from the sediments.

2.6.3 Particle Size Distribution in the Sediments

Particle size distribution of the sediments was determined based on the dry weight analysis of particles with different size. The supernatant left from the previous step (2.6.2) was carefully decanted, after which the remaining sediments were used for dry weight analysis [15].

3. Results and Discussion

3.1 Rainfall Record

Twelve rain events (represented as R1 to R12) with rainfall precipitations greater than 0.1 inch was sampled for the whole study. Ten events sampled during the period of July 13, 2004 and December 17, 2004 was used to conduct bacteria survivability and distribution study. Both sump water and sediments samples were taken one day, three day, and five day (or longer) after the cessation of each rain event. And for rain events 3 and 7, samples were also taken on the day that the rain occurred. Rain events also occurred on the following dates: 8/4, 9/9, 11/24, 11/25, 12/7, but no samples were collected. Rain events 11 and 12 were sampled in the summer of 2005 to evaluate the bacterial removal efficiency by the Vortechs (R1 was also used for this purpose). See Table 3-1 for detailed rainfall information related to each rain event.

Table 3-1. Rainfall Information

Rain Event	Rainfall Date	Precipitation amount, in	Duration, hr	Intensity, in/hr	Sampling Date
R1	7/13	0.41	12.75	0.03	7/13, 7/14, 7/16, 7/18
R2	7/18, 7/19	0.69	12	0.06	7/18, 7/20, 7/22
R3	7/24	0.15	3.25	0.05	7/24, 7/29
No sampling	8/4	1.59	22.75	0.07	
R4	8/15	1.63	8.25	0.20	8/16, 8/18, 8/20
R5	8/31	0.47	5.25	0.09	9/1, 9/3, 9/5
No sampling	9/9	0.52	4	0.13	
R6	10/16	1.05	11.5	0.09	10/17
R7	10/19	0.32	11.45	0.03	10/19, 10/24
R8	11/4	1.12	6.5	0.17	11/22
No sampling	11/24	0.41	5.75	0.07	
	11/25	0.53	17.5	0.03	
R9	12/1	1.23	7.25	0.17	12/2, 12/4, 12/6
No sampling	12/7	1.04	20.25	0.05	
R10	12/10	0.70	26.5	0.026	12/17
R11	5/25/05	0.46	18	0.026	5/25, 5/28
R12	7/8/05	0.57	20.5	0.03	7/8, 7/9, 7/11

3.2 Background Information

Samples were also collected on May 6, May 13, and May 21, 2005 from Site 2 during dry weather conditions to establish background information on pathogenic indicator bacteria in the sump water and Spectacle Pond (i.e. stream). As can be seen from Table 3-2, the bacterial concentrations in Spectacle Pond are higher than the bacterial standards for recreational water use in Rhode Island. This background information forms the baseline of this research.

Table 3-2. Background Bacteria Concentrations during Dry Weather

Pathogenic Indicator Bacteria (CFU or MPN/100mL)	Sump Water	Stream	Bacterial Standards for Recreational Water Use in RI [22]
<i>E. coli</i>	155±169	183±267	126
<i>Enterococci</i>	122±79	110±57	33
Fecal <i>Streptococci</i>	227±206	188±227	
Fecal Coliform	557±648	550±212	200
Total Coliform			1000

*Sample size: N=3

3.3 Removal Efficiency of Pathogenic Indicator Bacteria

Vortechs are somewhat effective in removing pathogens. Between 39-86% of all indicator bacteria were removed by Vortechs from both sampling sites, leaving another 14-61% of all bacteria in the sump water and/or sediments (Table 3-3).

Table 3-3. Bacteria Removal Efficiency

Pathogenic indicator bacteria removal	Site 1 (%)	Site 2 (%)
<i>E.coli</i>	41.7±34.1	66.8±10.8
<i>Enterococci</i>	71.4±40.4	62.7±8.4
Fecal <i>Streptococci</i>	55.6±8.8	53.3±35.7
Total Coliform	86.1±17.3	67.1±17.7
Fecal Coliform	73.0±3.4	39.2±29.1

*Sample size: N=3

The indicator bacteria concentrations were 2-25 times higher in the effluent discharged from Vortechs than that in the receiving water at Site 2 (see Table 3-4), indicating that bacteria concentrations after Vortechs treatment were still significantly high and this could significantly limit the use of receiving waters and raise concerns for public health.

The indicator bacteria concentrations in the sump (background was taken into account) were 3-7 times higher than that contributed by the incoming stormwater (i.e. the bacteria retained by Vortechs from fresh stormwater) (Table 3-4). This result suggests some bacteria are re-suspended from the sediments within Vortechs, which is consistent with the results shown later that bacteria may survive longer in the sediments.

Table 3-4. Impact of Vortechs on Bacteria Removal at Site 2

Pathogenic indicator bacteria	Ratio of bacteria in the effluent to that in the stream during rain events	Ratio of bacteria in the sump to the bacteria removed by Vortechs
<i>E.coli</i>	9±8	4.2±1.0
<i>Enterococci</i>	2	--
Fecal <i>Streptococci</i>	25±6	2.7±2.5
Total Coliform	14±16	3.4±0.5
Fecal Coliform	11±5	7.1±1.6

3.4 Temperature, pH, and DO

The sump water had warm temperature (~22 °C) during summer time (July and August, 2004, Figure 3-1). But the temperature started to drop since 10/17/2004 and went down to 7.7 °C on 12/17/2004. Lower temperature (10°C) was also detected for R11 and R12. No significant change of pH was observed (~7). For all the rain events monitored, dissolved oxygen (DO) was

high (~5 mg/L) on the days it rained (R3, R7, R11, R12) and one day after the rain event stopped. Then it quickly dropped to 1-2 mg/L three days after the rain stopped.

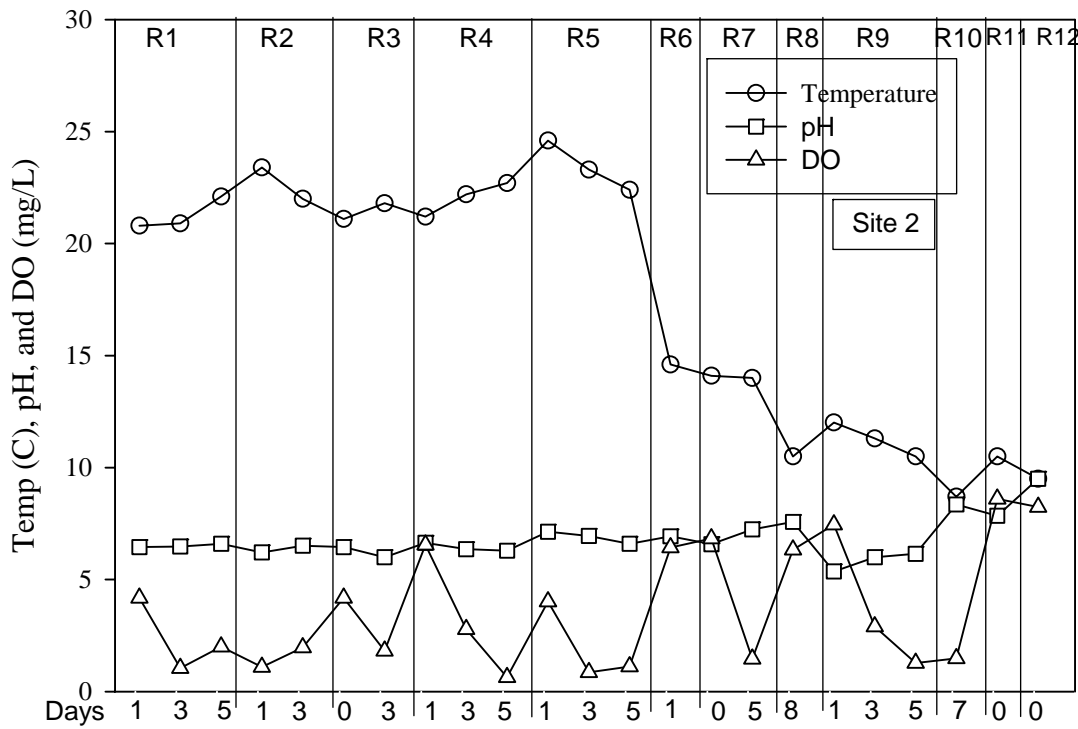
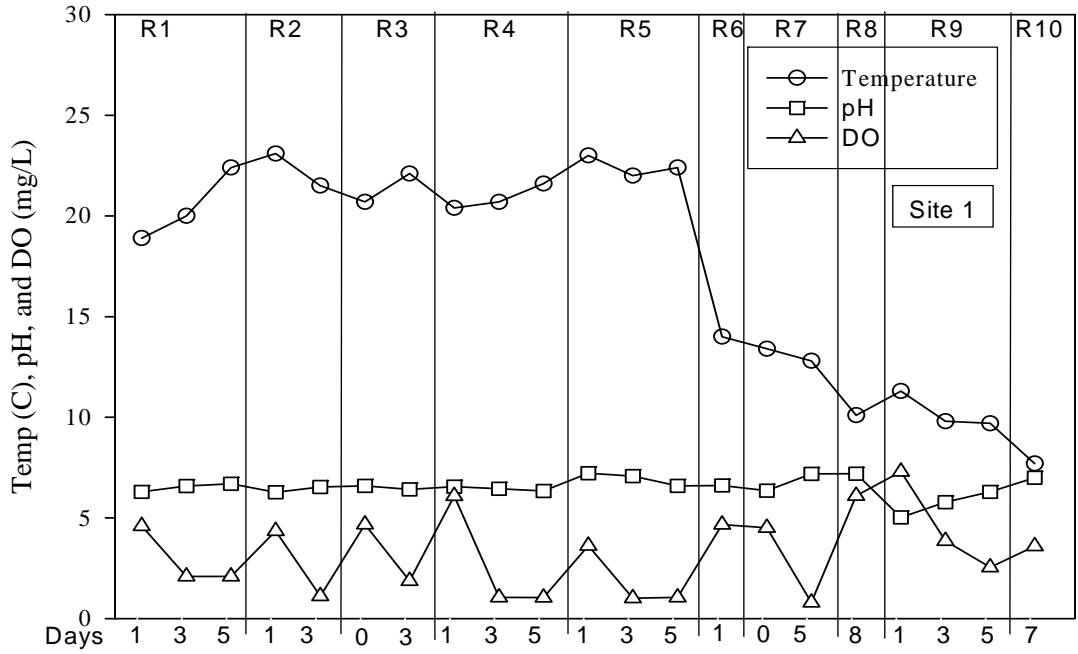

Figure 3-1. Temperature, pH, and DO in the Sump Water

3.5 Particle Size Distribution

Sump Water: From all the sump water samples taken, more than 70% of the suspended particles existed as less than 25 μm for both sampling sites. A slight shift in predominant particle size distribution was observed for site 1 (Figure 3-2). The percentage of smaller particles ($< 5 \mu\text{m}$) decreased but the percentage of larger particles ($> 5 \mu\text{m}$) increased with time, suggesting that suspended particles tend to aggregate and form larger particles over time. Towards the end of the study, much larger particles were predominant (25-50 μm). However, particle size distribution didn't change significantly at Site 2. A large number of particles ($(108,266 \pm 10,569)/100 \text{ mL}$) was detected in the sump water throughout the study.

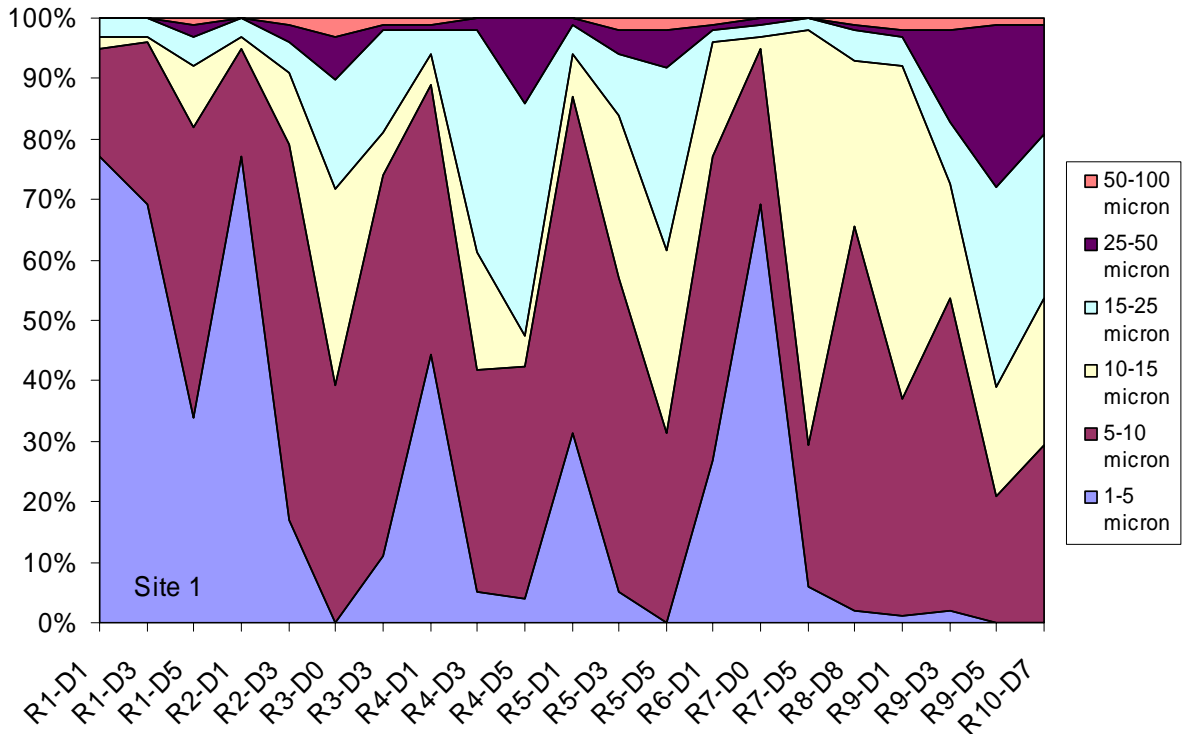

Figure 3-2a. Particle Size Distribution in the Sump Water (Site 1)

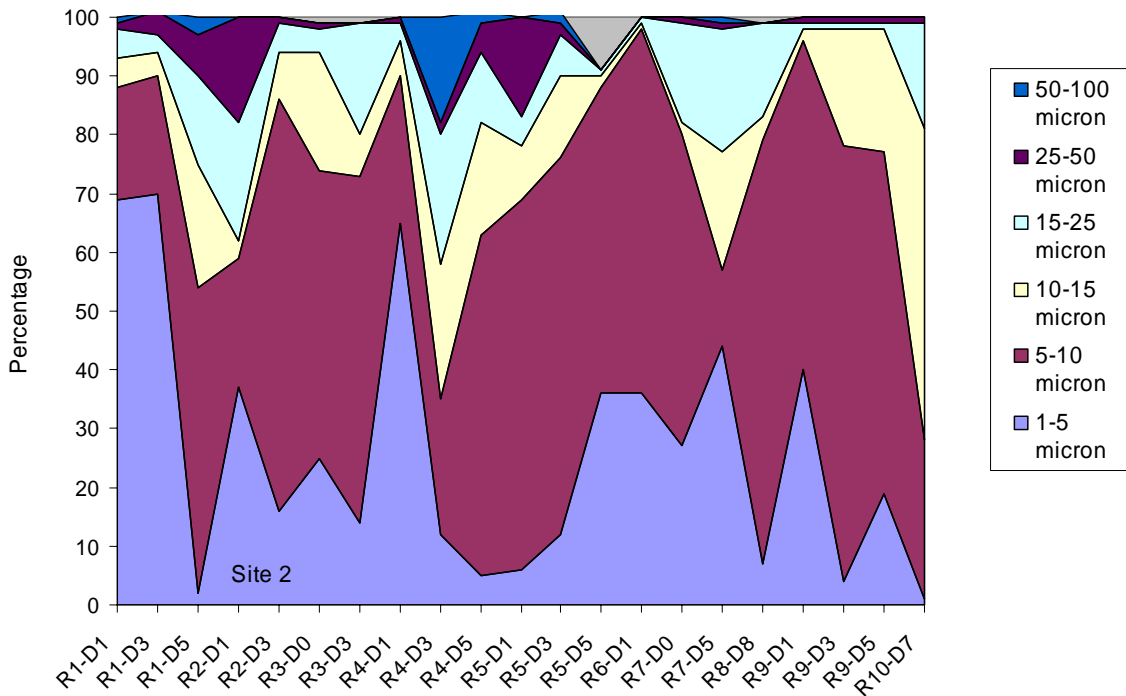

Figure 3-2b. Particle Size Distribution in the Sump Water (Site 2)

Sediments: In the sediments, smaller particles (< 106 μm) only accounted for 2% of the dry weight; larger particles (> 425 μm) accounted for 90% of the dry weight; medium particles (106 - 425 μm) accounted for 8% of the dry weight (Figure 3-3).

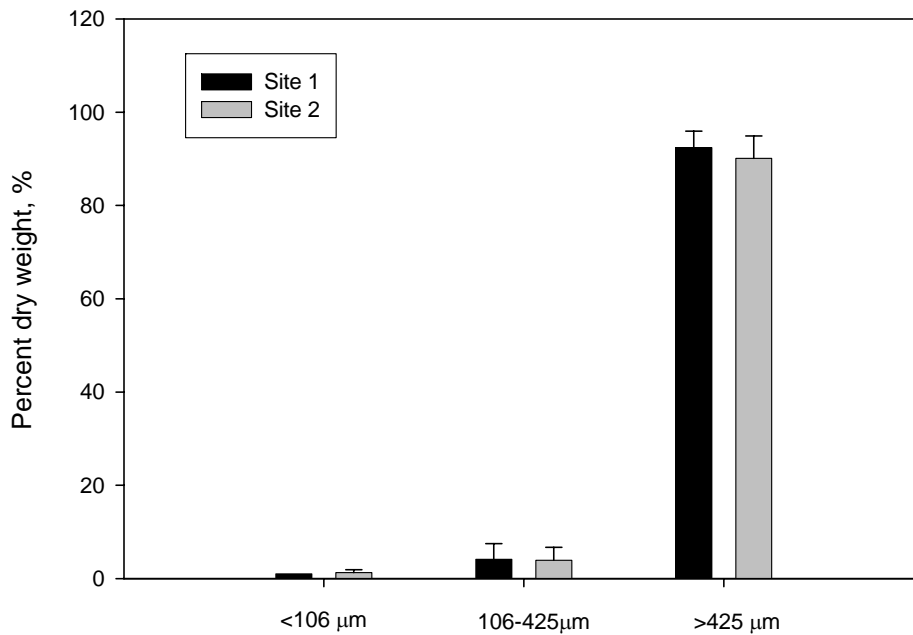

Figure 3-3. Particle Size Distribution in the Sediments

3.6 Bacteria Distribution within Vortechs

Sump Water: For the sump water samples from rain events 1-10, we found that 80% of all pathogenic indicator bacteria were associated with particles less than 50 μm (Figure 3-4). This finding is similar to what had been reported by Schillinger and Gannon [7], which about 15-20% of fecal coliform cells present in untreated stormwater were adsorbed to suspended particles greater than 30 μm in diameter.

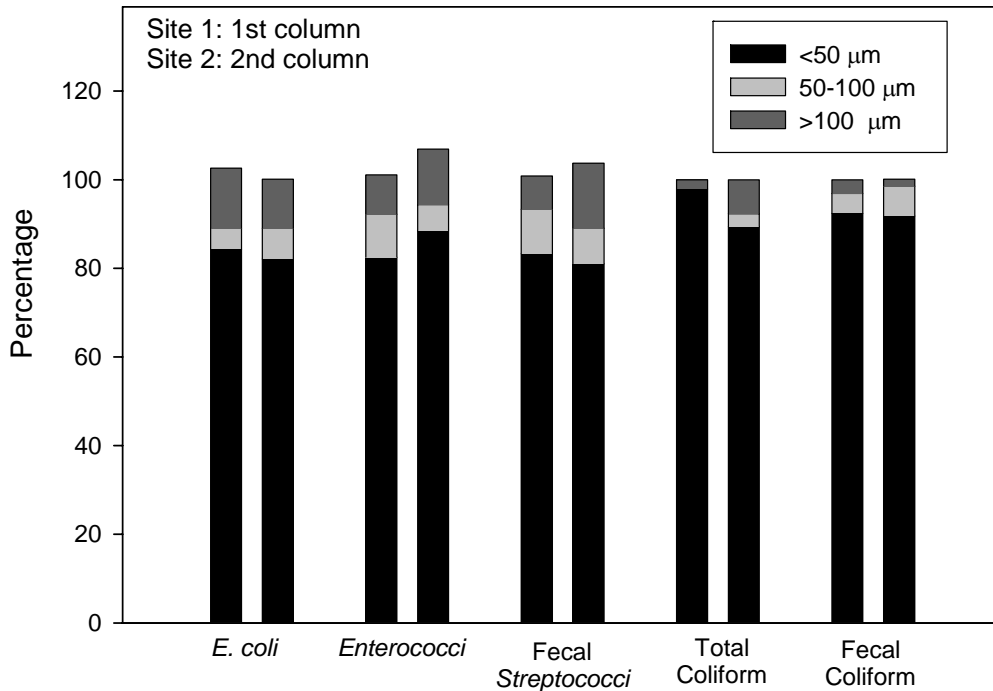

Figure 3-4. Bacteria Distribution in the Sump Water

Sediments: In the sediments, 60% of all indicator bacteria were associated with particles less than 106 μm , which accounted for only 2% of the total dry sediments. Small particles have large surface areas; therefore more bacteria are expected to be adsorbed to the smaller particles (Figure 3-5).

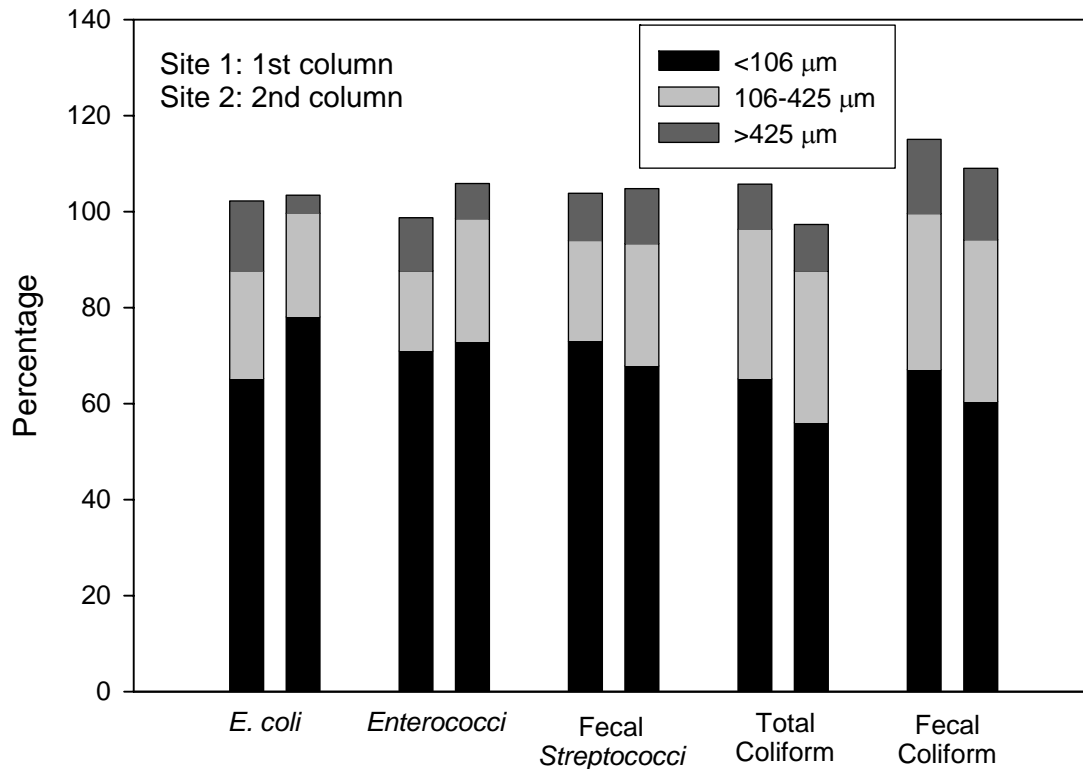

Figure 3-5. Bacteria Distribution in the Sediments

3.7 Bacteria Survivability

Sump Water: A surge of all indicator bacteria was detected on the day there was a rain event (R3-D0 and R7-D0) and one day after the cessation of rain events for R1-R10 with only few exceptions (at Site 1, *enterococci* of R1, *enterococci* and fecal *streptococci* of R2, etc. see Figure 3-6). All indicator bacteria concentrations decreased sharply three days, five days, and eight or seven days (R8 and R10) after the cessation of rain events. Therefore, there was no re-growth of bacteria in the Vortechs unit over time. Apparently temperature affected the bacterial concentrations significantly. Much lower temperatures were recorded for rain events 9 and 10 resulting lower bacterial concentrations. Much lower bacteria concentrations were detected at Site 2 than that at Site 1, suggesting a higher bacterial contamination from street and highway runoff.

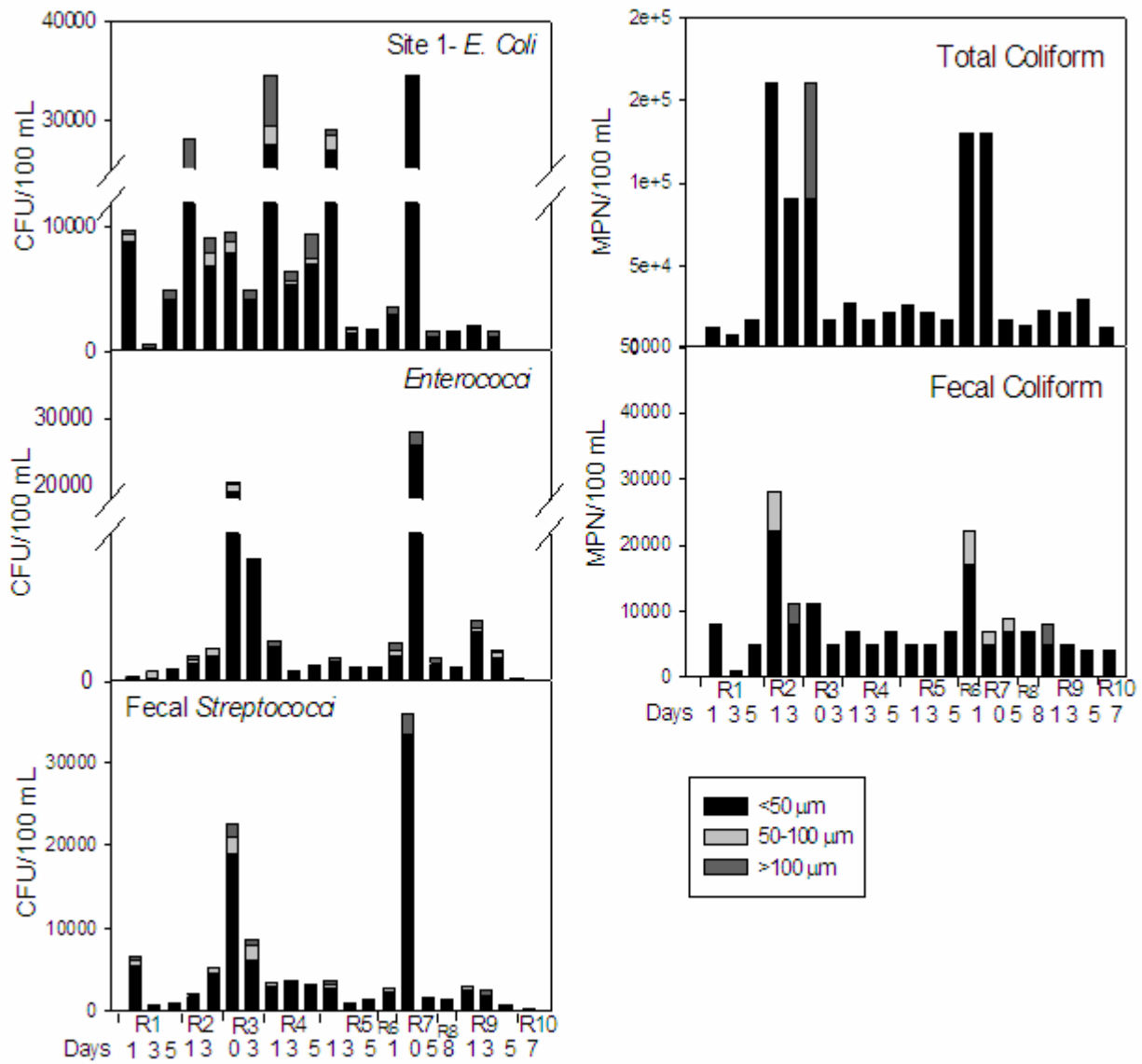

Figure 3-6a. Bacteria Survivability in the Sump Water (Site 1)

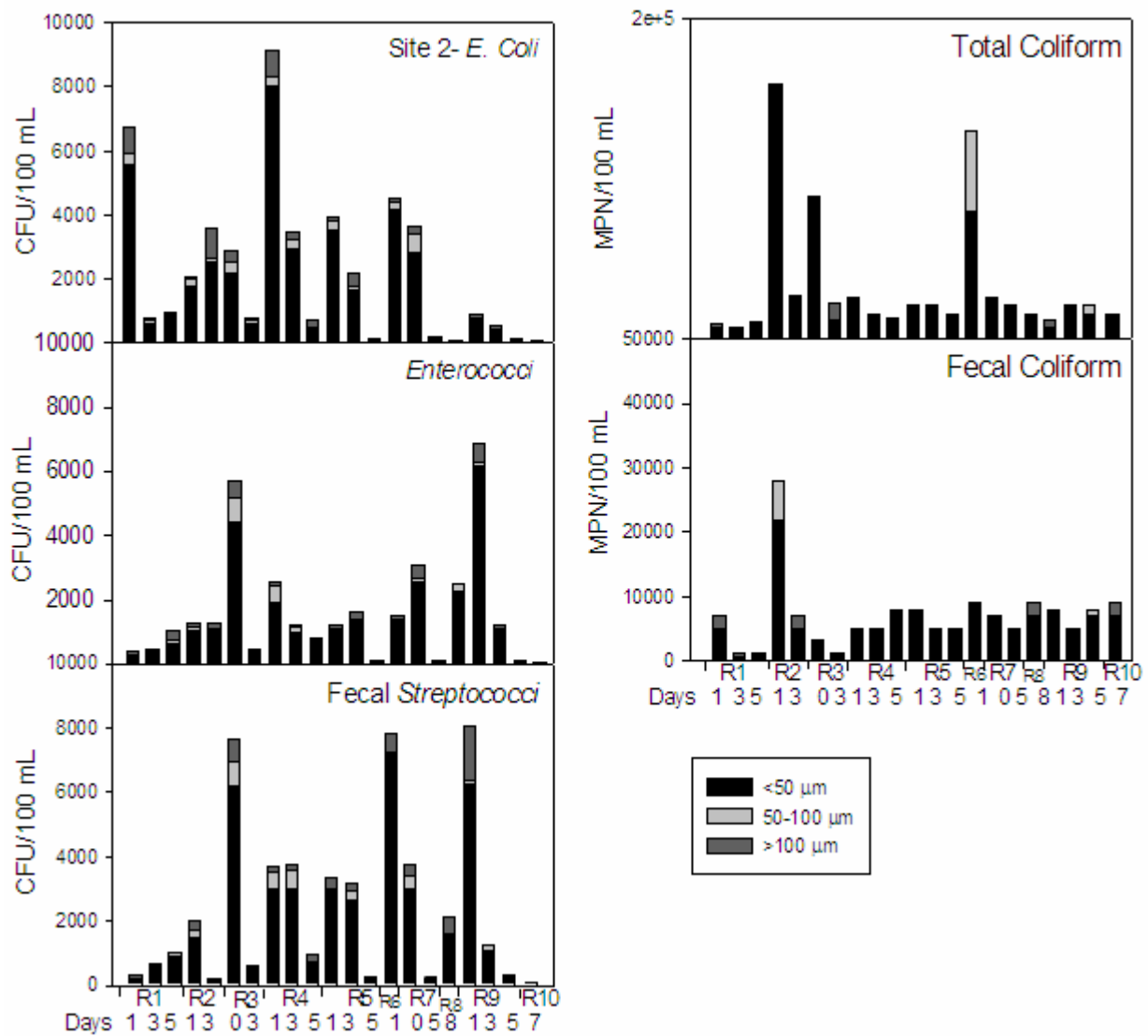

Figure 3-6b. Bacteria Survivability in the Sump Water (Site 2)

Sediments: Contrary to the results of the sump water, no dramatic decrease of all indicator bacteria happened over a five day period after the rain stopped (Figure 3-7) and higher bacterial concentrations were detected in the sediments than that in the sump water (more significant at Site 2), suggesting that sediments may have provided a favorable living environment for bacteria. Starting from rain event 6 (10/17/2004), the temperature started to drop drastically. Apparently temperature affected *E. coli* the most. The concentration of *E. coli* had dropped to a very low level since R9. A steady decrease in *Enterococci* and Fecal *Streptococci* was observed over time; however, their concentrations were much higher comparing to that of *E. coli*, suggesting that *Enterococci* and Fecal *Streptococci* can survive longer than *E. coli*. For this reason, Van Donsel and Geldreich [14] suggested that *Enterococci* may be better indicators of sediment contamination.

The surge of all bacteria in the sump water as happened on the day it rained and one day after the rain stopped could be attributed to the re-suspension of bacteria from the sediments. Re-suspension of bacteria adds extra loading to the Vortechs treatment units and may reduce the treatment efficiency of the units. Therefore, maintenance strategies such as regular cleaning and routine checking may be necessary to enhance the units' treatment efficiency. The re-suspension of bacteria also seems to correlate very well with the dissolved oxygen concentrations, suggesting that there might be moderate biological activities occurring in the Vortechs.

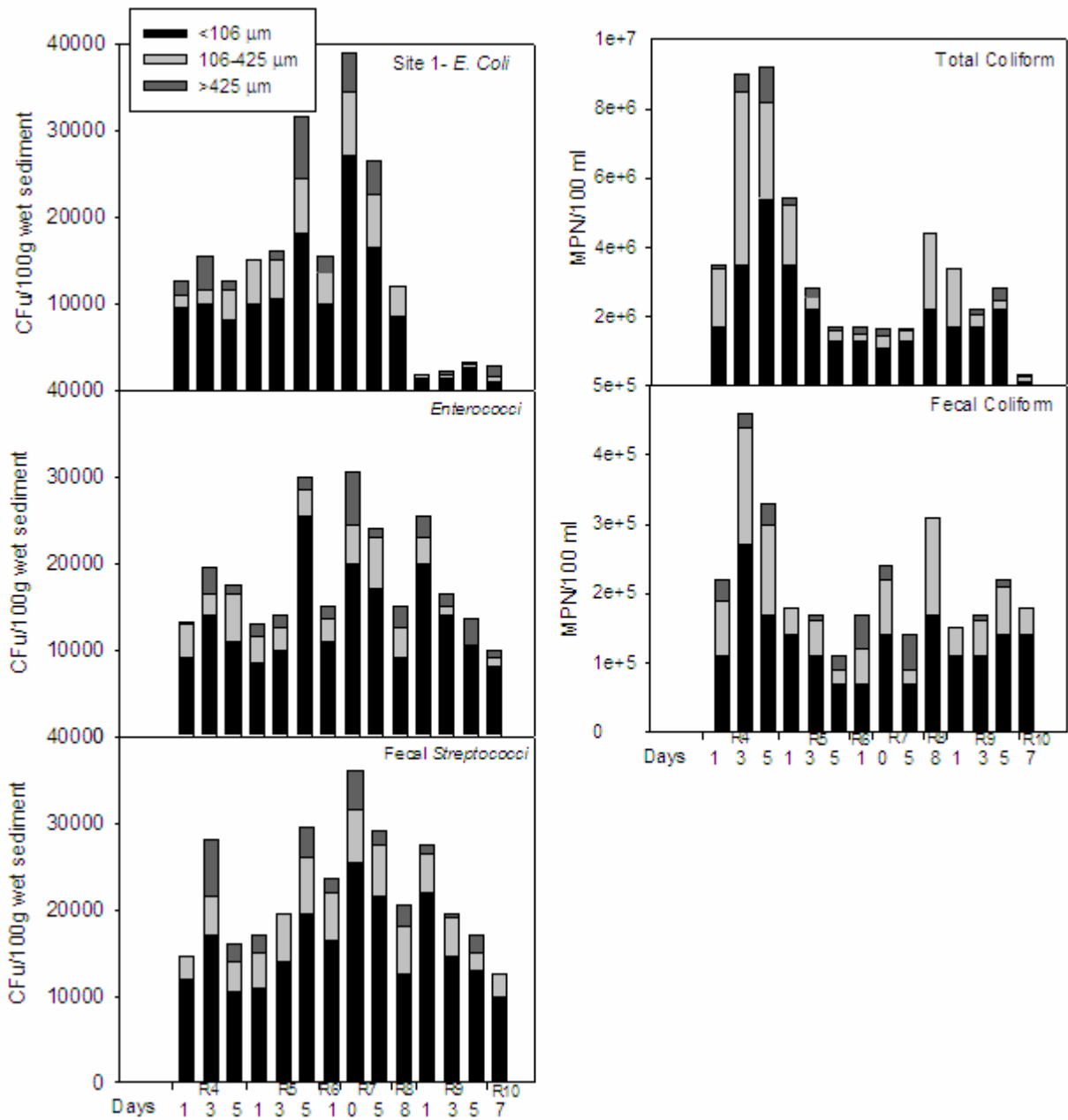
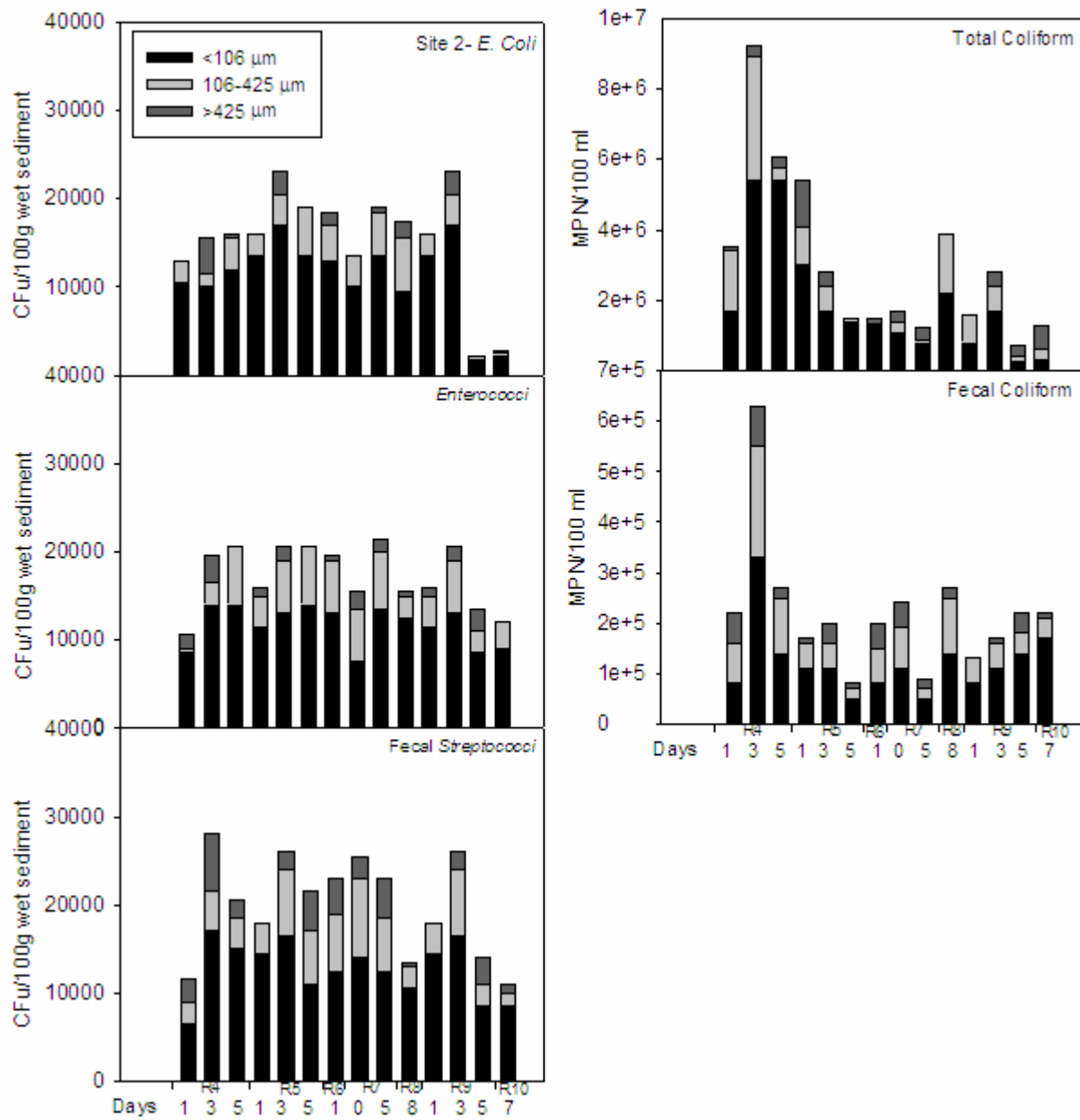

Figure 3-7a. Bacteria Survivability in the Sediments (Site 1)



3.8 Ratio of Fecal Coliform to Fecal *Streptococci*

The ratios of Fecal Coliform to Fecal *Streptococci* at both sites were greater than 4, with the ratios at Site 1 much less than that at Site 2 (Figure 3-8). These values suggest the contamination source was from human.

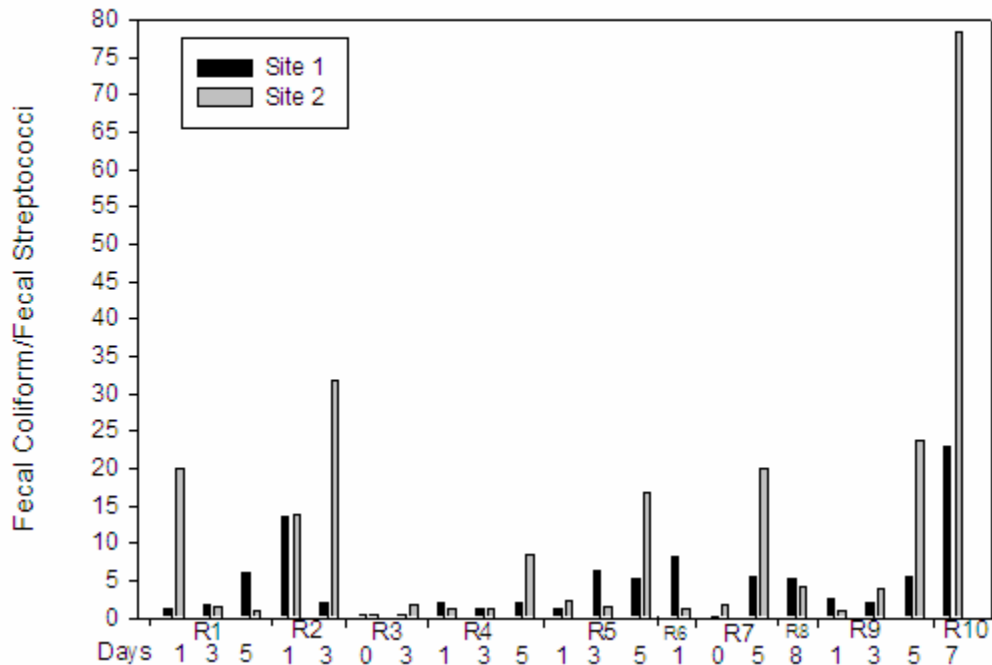

Figure 3-8. Ratio of Fecal Coliform to Fecal *Streptococci*

4. Conclusions

This study evaluated the bacteria removal efficiency, and particle size distribution, bacteria distribution and survivability within Vortechs. The following conclusions can be made:

- Vortechs was effective in partial removal of pathogenic indicator bacteria (39-86%), however, the bacteria concentrations after BMP treatment were still significantly high and this could limit the use of receiving waters and raise concerns for public health.
- The indicator bacteria concentrations in the sump water were 3-7 times higher than that contributed by the incoming stormwater. This result suggests some bacteria were re-suspended from the sediments within the Vortechs.
- In the sump water, a surge of bacteria concentration happened on the day a rain event occurred and one-day after the rain stopped. On the contrary, no significant change in the concentrations of bacteria was detected in the sediments over time.
- Higher bacterial concentrations were detected in the sediments than in the sump water.

- The survivability of bacteria is low in the sump water but high in the sediments, suggesting that sediments may provide a favorable living environment for bacteria and the surge of bacteria in the sump water may be due to bacteria re-suspension from the sediments.
- Majority of the particles in the sump water was less than 25 μm .
- Majority of the bacteria were associated with smaller particles (<50 μm in the sump water, and <106 μm in the sediments).
- Apparently *Enterococci* and fecal *streptococci* can survive longer than *E. coli* under colder temperature.
- The sump water at Site 2 had much lower bacteria concentrations than that at Site 1 suggesting a higher bacteria contamination from highway runoff.

5. Recommendations for Structural BMP Management

Our research results suggest that Vortechs can only partially remove bacteria. Therefore maintenance strategies such as more frequent sediment removal may be necessary to prevent pathogen-rich washouts to receiving waters. Structural BMPs near busy streets and highway should be cleaned out more frequently.

6. References

1. EPA, *Water Quality Conditions in the United States: A Profile from the 1998 National Water Quality Inventory Report to Congress*. 2000, Office of Water.: Washington, DC.
2. Oliveri, V.P., Kruse, C.W., Kawata, K., and Smith, J.E., *Microorganisms in Urban Stormwater*. 1977.
3. EPA, *Stormwater Technology Fact Sheet: Hydrodynamic Separators*. 1999.
4. Pitt, R., Clark, S., and Field, R., Groundwater Contamination Potential from Stormwater Infiltration Practices. *Urban Water*, 1999. **1**: p. 217-236.
5. Vaze, J. and Chiew, F.H.S., Nutrient Loads Associated with Different Sediment Sizes in Urban Stormwater and Surface Pollutants. *J. Environ. Eng.*, 2004. **130**(4): p. 391-396.
6. Sartor, J.D. and Gaboury, D.R., Street Sweeping as a Water Pollution Control Measure: Lessons Learnt over the Past Ten Years. *Sci. Total Environ.*, 1984. **33**: p. 171-183.
7. Schillinger, J.E. and Gannon, J.J., Bacterial Adsorption and Suspended Particles in Urban Stormwater. *J. Water Pollution Control Federation*, 1985. **57**: p. 384-389.
8. Sansalone, J.J. and Tribouillard, T., Variation in Characteristics of Abraded Roadway Particles as a Function of Particle Size: Implications for Water Quality and Drainage. *Transportation Research Record*, 1999. **1690**: p. 153-163.
9. Metcalf and Eddy, *Wastewater Engineering - Treatment and Reuse*. 4th edn. 2003: McGraw Hill.
10. Scott, T.M., Rose, J.B., Jenkins, T.M., Farrah, S.R., and Lukasik, J., Microbial Source Tracking: Current Methodology and Future Directions. *Applied and Environmental Microbiology*, 2002. **68**(12): p. 5796-5803.
11. Borrego, J.J., Arrabal, F., de Vicente, A., Gomez, L.F., and Romero, P., Study of Microbial Inactivation in the Marine Environment. *J. Water Pollution Control Federation*, 1983. **55**: p. 297-302.

12. Dufour, A.P., Strickland, E.R., and Cabelli, V.J., Membrane Filter Method for Enumerating Escherichia Coli. *Applied and Environmental Microbiology*, 1981. **41**: p. 1152-1158.
13. Troy, M.S., Joan, B.R., Tracie, M.J., Samuel, R., and Jerzy, L., Microbial Source Tracking: Current Methodology and Future Directions. *Applied and Environmental Microbiology*, 2002(5796-5803).
14. Van Donsel, D.J. and Geldreich, E.E., Relationship of Salmonellae to Fecal Coliforms in Bottom Sediments. *Wat. Res.*, 1971. **5**: p. 1079-1087.
15. APHA, AWWA, and WEF, *Standard Methods for the Examination of Water and Wastewater*. 20th ed, ed. L.S. Clesceri, A.E. Greenberg, and A.D. Eaton. 1998, Washington, D.C.
16. LaMontagne, M.G. and Holden, P.A., Comparison of Free-Living and Particle-Associated Bacterial Communities in a Coastal Lagoon. *Microbial. Ecol.*, 2003. **46**: p. 228-237.
17. www.vortech.com. Last accessed 8/28/2005.
18. EPA, *Microbiological Methods for Monitoring the Environment: Water and Wastes*. 1978: Washington, D.C.
19. EPA, *Improved Enumeration Methods for the Recreational Water Quality Indicators: Enterococci and Escherichia Coli*. 2000: Washington DC.
20. EPA, *Method 1603: Escherichia Coli (E. Coli) in Water by Membrane Filtration Using Modified Membrane- Thermotolerant Escherichia Coli Agar (Modified MTEC)*. 2002.
21. Davies, C.M., Yousefi, Z., and Bavor, H.J., Occurrence of Coliphages in Urban Stormwater and Their Fate in Stormwater Management Systems. *Letters in Applied Microbiology*, 2003. **37**: p. 299-303.
22. Addy, K., Herron, E., and Green, L., *Bacteria Monitoring, Uri Watershed Watch*. 2003.